



JF 40



Uma capacidade de elevação extraordinária para um mini guindaste que é extremamente intuitiva.

Sua versatilidade permite operar nos mais diversos campos: da vidraçaria ao tradicional canteiro de obras, o guindaste sobre esteiras JF40 se adapta a qualquer situação.





JF 40

JF40



2500 kg



2380 x 780 x 1820 mm











8.1m



6.8 m

Informação Técnica

Dimension	 L x W x H	2380 x 780 x 1820 mm
Stab. Area		4550 X 4550 mm

		Kg
Crane & Options Weights	 JF40	1500
		/
	 TF0500	12
	 AUX PP400-4DX PP220-4DX PP220-2DX	40
	 JIB P	9

Winch		600 kg 36 m - Ø 6 mm 27-33 m/min.
-------	---	---

JF40	Petrol Engine	YAMAHA MZ 360	7.6 kW 10.4 Hp
------	---------------	------------------	-------------------

Speed		2.4 km/h
Gradeability		25°

Gráfico de carga

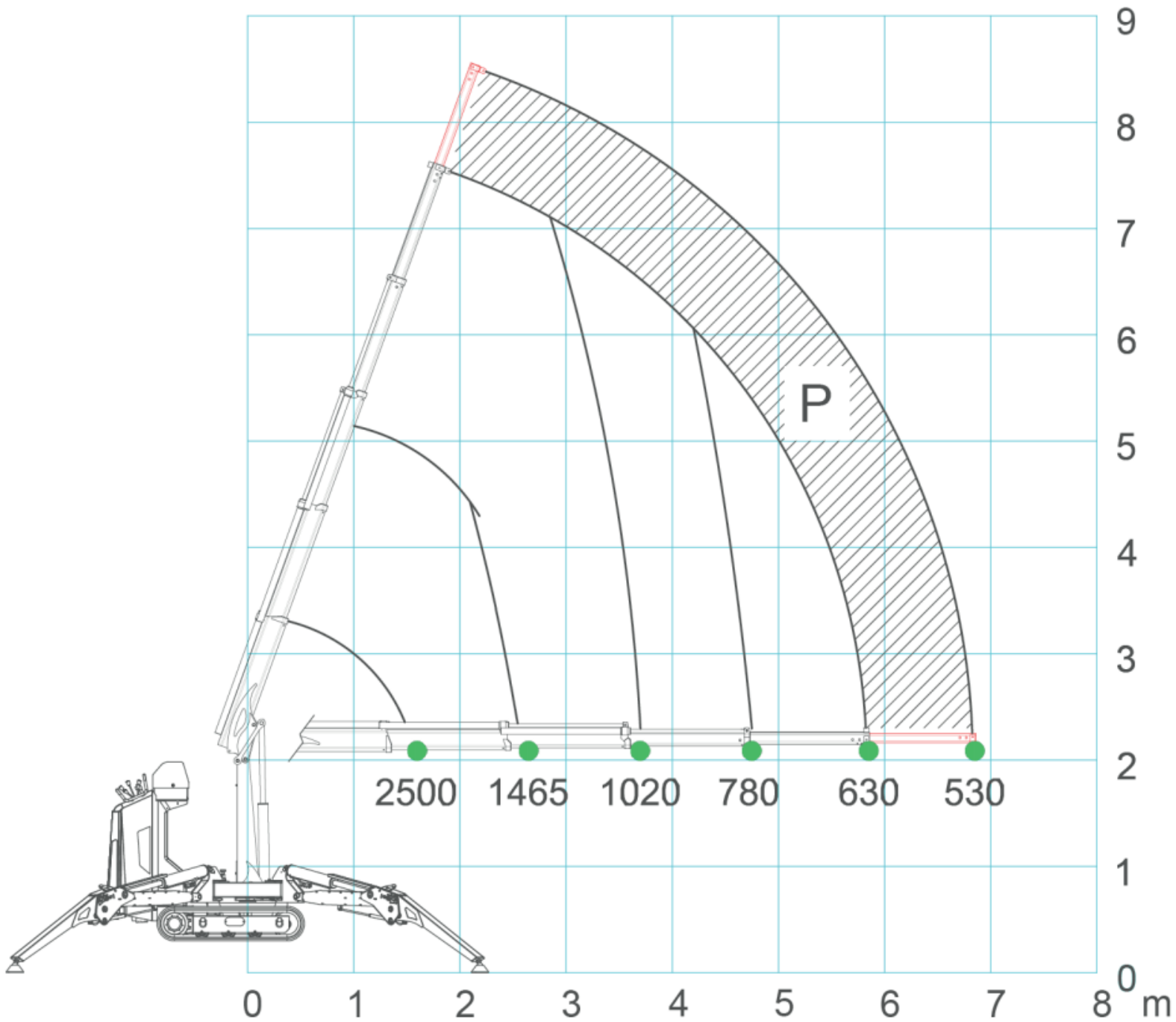



JF 40

Pacote de energia elétrica

 AUX	400V 3-AC 4kW / 5.3 HP
	230V AC 2.2kW / 2.9 HP

Carga máxima da faixa



0.42 kg/cm²

carga máxima do estabilizador



1530 kg

Comprimento da lança

1.6 - 5.8 m 30 sec.

Ângulo de trabalho

0° / 70° 14 sec.

Rotação

330° / 30 sec.

Dimensões

