

200-E3 Spider



Dados Técnicos

Motor Elétrico de partida gasolina	Honda GX 390-13HP a 3500 rpm
Capacidade do tanque .	6L.
Direção Hidrostática a 2 velocidades	Km/h 1,7-2,5
Ângulo de rampa	20° (36%)
Esteiras de borracha	1165 x 180 x 20 mm
Levantamento máximo x.	1500kg.
Raio máx. de trabalho	6,20m.
Altura máxima de trabalho	8,00m.
Cabo do guincho	30m. o 8mm.
Rotação	360°
Estabilizadores	Hidráulico
Carregamento máx. pista	0,26 Kg/cm²
Controles elétricos proporcionais	
Dispositivo limitador automático	Eletrônico
Pressão máxima	180 bar
Dimensões Guindastes	1700 x 750 x 1620 mm. sem opcionais
Peso do Guindaste sem contrapeso	1000 Kg. sem opcionais



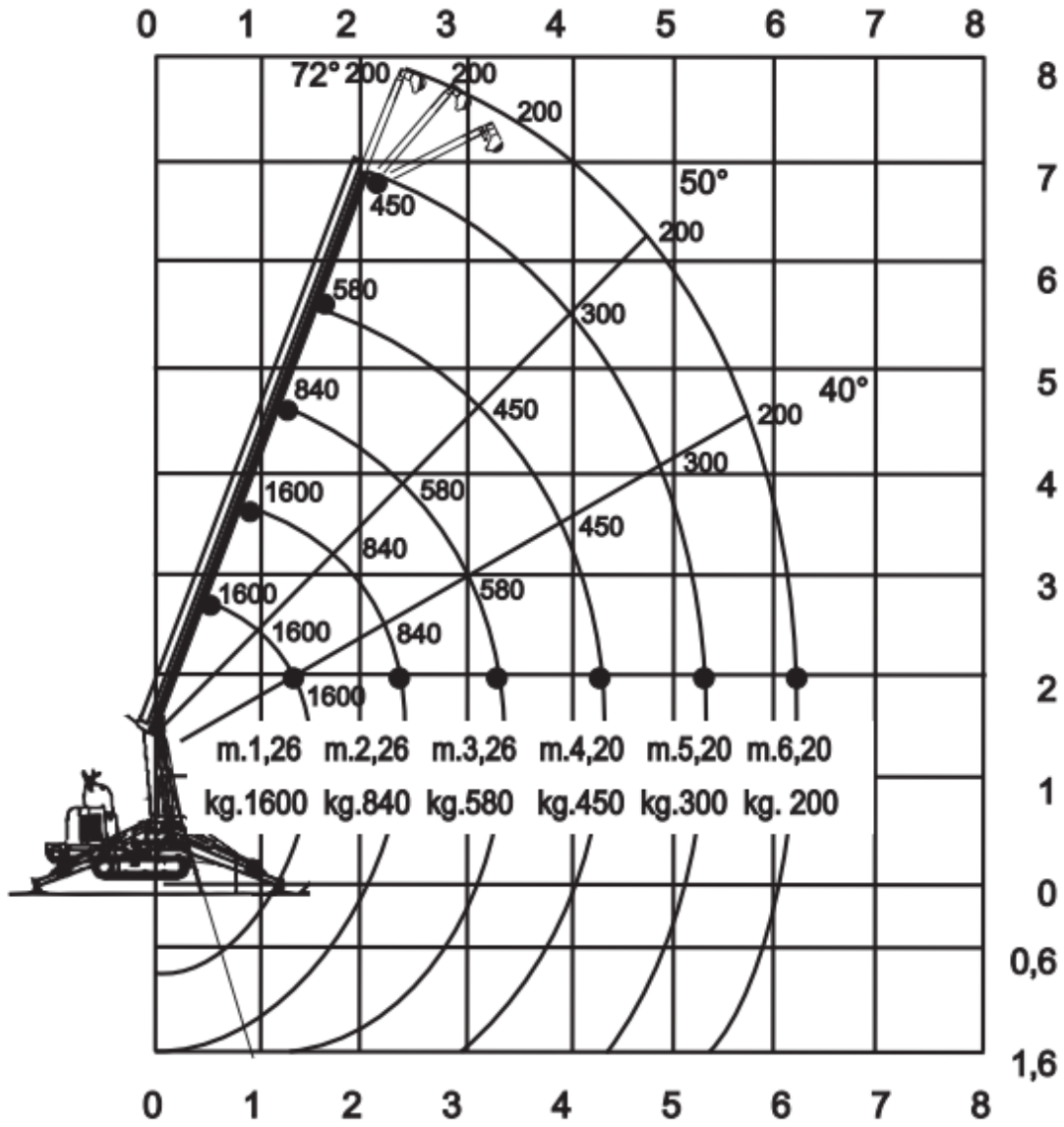

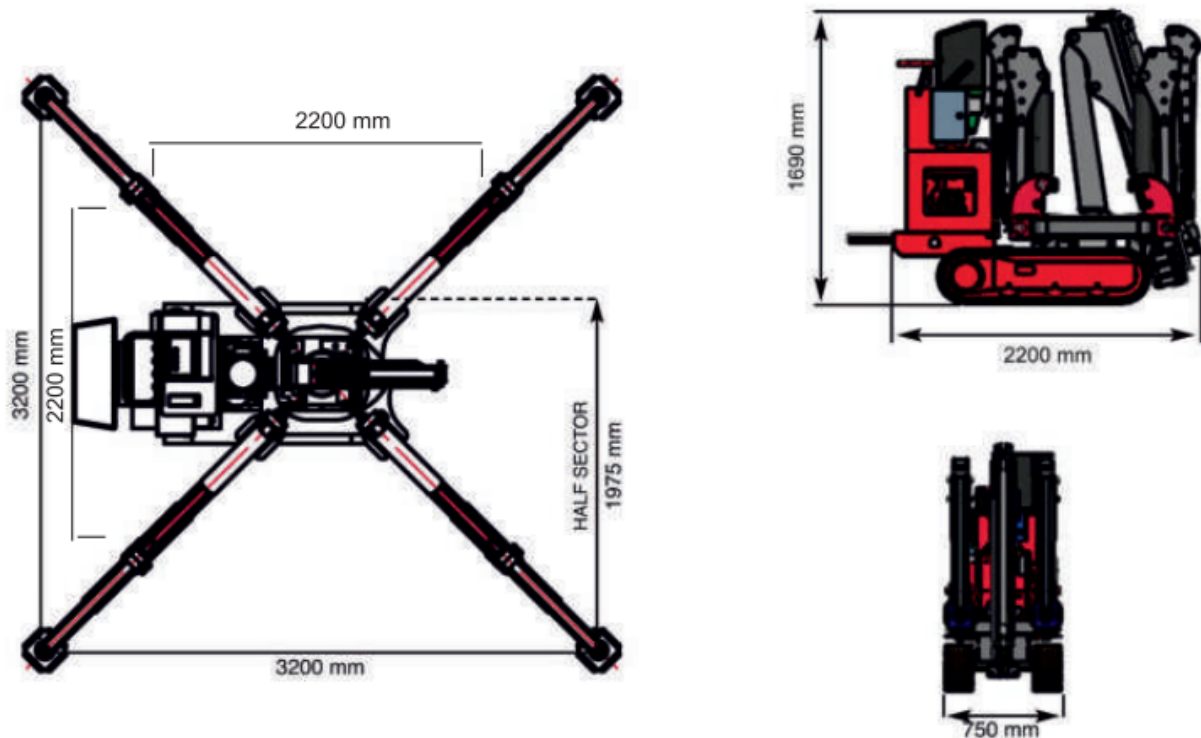

Tabela de carga



Dimensões



Opcionais

 <p>Verricello Winch Treuil Seilwinde Cabrestante</p>	 <p>Elettropompa 115-220-380 V Electric pump 115-220-380 V Pompe électrique 115-220-380 V Elektrische pumpe 115-220-380 V Bomba eléctrica 115-220-380 V</p>	 <p>Radiocomando Radio remote control Radiocommande Funkfernsteuerung Radiocomando</p>	 <p>Cestello Basket Nacelle Personenkorb Cesta</p>
 <p>Prolunghe meccaniche Manuals extensions Rallonges manuelles Manuelle verlängerung Alargadores mecánicos</p>	 <p>Allargamento idraulico cingoli mm. 750/1050 Widening hydraulic tracks mm. 750/1050 Élargissement hydraulique des chenilles mm. 750/1050 Hydraulisch austauschbare raupenkettens mm. 750/1050 Ensanche hidráulicos orugas mm. 750/1050</p>	 <p>Sollevatore a ventosa portata max +0 400 - 1200 Kg Vacuum lifter max lifting +0 400 - 1200 Kg élevateur à vide carga maxima +0 400 - 1200 Kg levantador de vacío capacidad max +0 400 - 1200 Kg Vakuumheber max Tragfähigkeit +0 400 - 1200 Kg</p>	

